

Industriefunkuhren



Technical Manual

Optocoupler- and Relay Board

Model 7112/7121

ENGLISH

Version: 26.00 – 08.06.2006

Valid for Devices 7112/7121 with FIRMWARE Version: 26.xx

Version number (Firmware / Manual)

THE FIRST TWO DIGITS OF THE VERSION NUMBER OF THE TECHNICAL MANUAL AND THE FIRST TWO DIGITS OF THE FIRMWARE VERSION MUST **COMPLY WITH EACH OTHER**. THEY INDICATE THE FUNCTIONAL CORRELATION BETWEEN DEVICE AND TECHNICAL MANUAL.

THE DIGITS AFTER THE POINT IN THE VERSION NUMBER INDICATE CORRECTIONS IN THE FIRMWARE / MANUAL THAT ARE OF NO SIGNIFICANCE FOR THE FUNCTION.

Downloading Technical Manuals

All current manuals of our products are available free of charge via our homepage on the Internet.

Homepage: <http://www.hopf.com>

E-Mail: info@hopf.com

Symbols and Characters



Operational Reliability

Disregard may cause damages to persons or material.



Functionality

Disregard may impact function of system/device.



Information

Notes and Information.



Safety regulations

The safety regulations and observance of the technical data serve to ensure trouble-free operation of the device and protection of persons and material. It is therefore of utmost importance to observe and compliance with these regulations.

If these are not complied with, then no claims may be made under the terms of the warranty and no liability will be assumed for any ensuing damage.



Safety of the device

This device has been manufactured in accordance with the latest technological standards and approved safety regulations

The device should only be put into operation by trained and qualified staff. Care must be taken that all cable connections are laid and fixed in position correctly. The device should only be operated with the voltage supply indicated on the identification label.

The device should only be operated by qualified staff or employees who have received specific instruction.

If a device must be opened for repair, this should only be carried out by employees with appropriate qualifications or by **hopf** Elektronik GmbH.

Before a device is opened or a fuse is changed all power supplies must be disconnected.

If there are reasons to believe that the operational safety can no longer be guaranteed the device must be taken out of service and labelled accordingly.

The safety may be impaired when the device does not operate properly or if it is obviously damaged.

CE-Conformity



This device fulfils the requirements of the EU directive 89/336/EWG "Electromagnetic compatibility" and 73/23/EWG "Low voltage equipment".

Therefore the device bears the CE identification marking (CE=Communauté Européenne)

CE = Communautés Européennes = European communities

The CE indicates to the controlling bodies that the product complies with the requirements of the EU directive - especially with regard to protection of health and safety for the operator and the user - and may be released for sale within the common markets.

Contents	Page
1 General Information.....	7
1.1 Optocoupler Board 7112.....	7
1.1.1 Position Print.....	7
1.1.2 Contact Assignment of the 96-pole VG-Strip in the Front Panel.....	8
1.1.3 Example Wiring for Optocoupler Board 7112.....	9
1.1.4 Technical Data - Board 7112.....	10
1.2 Relay Board 7121.....	11
1.2.1 Position Print.....	11
1.2.2 Contact Assignment of the 96-pole VG-Strip in the Front Panel.....	12
1.2.3 Example Wiring for Relais Board 7121.....	13
1.2.4 Technical Data - Board 7121.....	14
2 Operating Modes	15
2.1 Function of the Input Optocoupler.....	15
2.2 DIP-Switch Settings.....	16
2.2.1 Mode 0 : Output of Time as BCD-Information.....	19
2.2.2 Mode 1 : Output of 24 Minute Pulses (same pulse duration).....	21
2.2.3 Mode 2 : Output of 3x8 Minute Pulses (different pulse duration).....	21
2.2.4 Mode 3 : Output of 24 DCF77-Simulation Pulses.....	21
2.2.5 Mode 4 : Output of Error Messages.....	21
2.2.6 Mode 5 : Output of Second Pulses.....	22
2.2.7 Mode 6 : Output Date with Status.....	23
2.2.8 Mode 7 : Output of Minute-, Hour-, Day Pulses.....	24
2.2.9 Mode 8 : Output of Minute-, Toggle- and Alarm Pulses.....	25
2.2.10 Mode 9 : Output of Different Pulses.....	26
2.2.11 Mode 10 : Output of Different Synchronous Pulses.....	27
2.2.12 Mode 11 : Output of Different Synchronous Pulses.....	28
2.2.13 Mode 12 : Output of Different Synchronous Pulses.....	29
2.2.14 Mode 13 : Output Minute-, Hour, Day Pulses and Status.....	30
2.2.15 Mode 14 : Output of Different Synchronous Pulses and Error Messages.....	31
2.2.16 Mode 15 : Output of Hour Pulses (Same Pulse Duration).....	32
2.2.17 Mode 16 : Output of Different Synchronous Pulses.....	33
2.2.18 Mode 17 : Output of Minute-, Daylight Saving Time- and Status Bit.....	34
2.2.19 Mode 18 : Output Mains Frequency and Difference Time.....	35
2.2.20 Mode 19 : Output of Error Messages and Hour Pulses.....	38
2.2.21 Mode 20 : Output of 24 Error Messages.....	39
2.2.22 Mode 21 : Output of Hour, 15 Minute and Minute Pulses.....	40
2.2.23 Mode 22 : Output of Different Pulses and Status.....	41
2.2.24 Mode 23 : Output of Hour Pulses every Hour.....	42
2.2.25 Mode 24 : Output of Minute and 5 Second Pulses.....	43

1 General Information

There are two different parallel Output Boards available for the system 7000 and 7001.

- Optocoupler Board 7112
- Relay Board 7121

1.1 Optocoupler Board 7112

The board 7112 has 24 optocoupler exits where potential free signals/pulses can be put out. There are also 8 optocoupler inputs for different tasks and purposes on the board.

The board contains its own microprocessor, which organises the synchronization with the system 7001 and the in- and output.

The board can be configure for the use with the clock-system 7000 or 7001 with Jumper **M0**.

1.1.1 Position Print

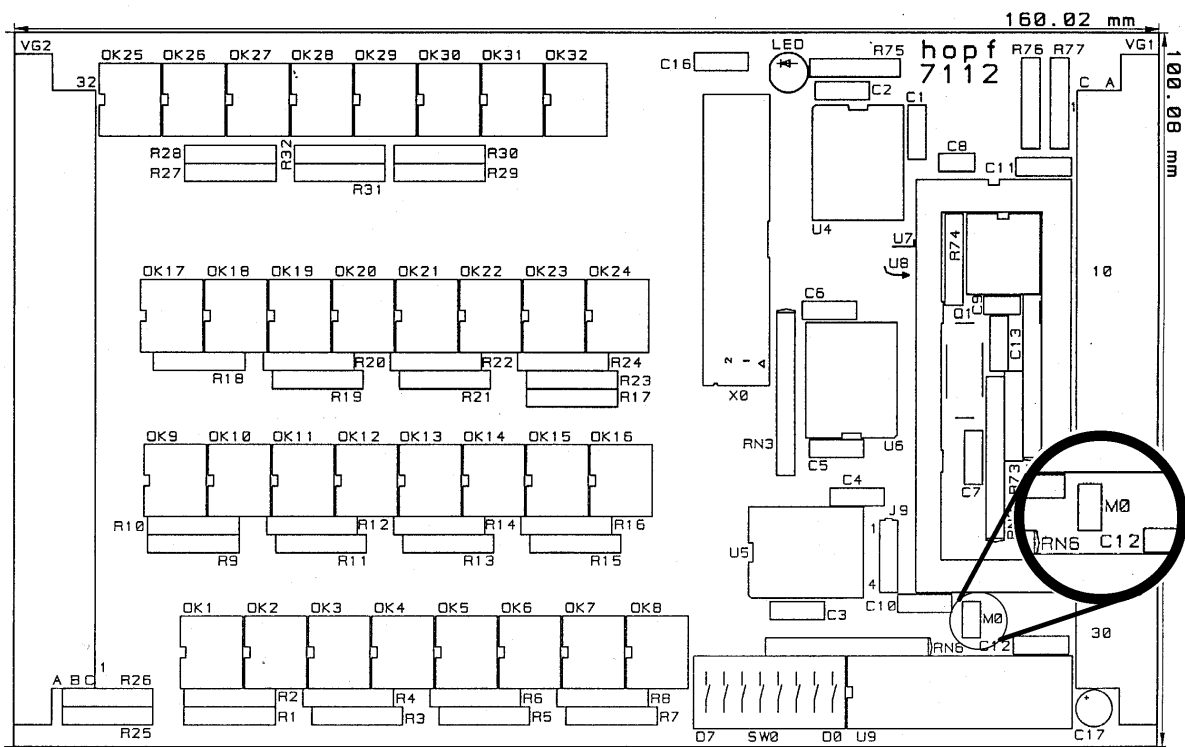

Setting for clock-system 7001 (Board 7015 as Master-Clock):

Jumper M0 open

Setting for clock-system 7000 (Board 7010 as Master-Clock):

Jumper M0 close

1.1.2 Contact Assignment of the 96-pole VG-Strip in the Front Panel

Signals: E = emitter of the output transistor
 C = collector of the output transistor
 OA = anode of the input diode
 OK = cathode of the input diode

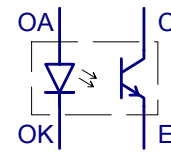

pin	VG-strip			
	a	b	c	
1	OA		OK	input optocoupler 1
2	OA		OK	input optocoupler 2
3		E	C	output optocoupler 1
4		E	C	output optocoupler 2
5		E	C	output optocoupler 3
6		E	C	output optocoupler 4
7		E	C	output optocoupler 5
8		E	C	output optocoupler 6
9		E	C	output optocoupler 7
10		E	C	output optocoupler 8
11	OA		OK	input optocoupler 3
12	OA		OK	input optocoupler 4
13		E	C	output optocoupler 9
14		E	C	output optocoupler 10
15		E	C	output optocoupler 11
16		E	C	output optocoupler 12
17		E	C	output optocoupler 13
18		E	C	output optocoupler 14
19		E	C	output optocoupler 15
20		E	C	output optocoupler 16
21	OA		OK	input optocoupler 5
22	OA		OK	input optocoupler 6
23		E	C	output optocoupler 17
24		E	C	output optocoupler 18
25		E	C	output optocoupler 19
26		E	C	output optocoupler 20
27		E	C	output optocoupler 21
28		E	C	output optocoupler 22
29		E	C	output optocoupler 23
30		E	C	output optocoupler 24
31	OA		OK	input optocoupler 7
32	OA		OK	input optocoupler 8

1.1.3 Example Wiring for Optocoupler Board 7112

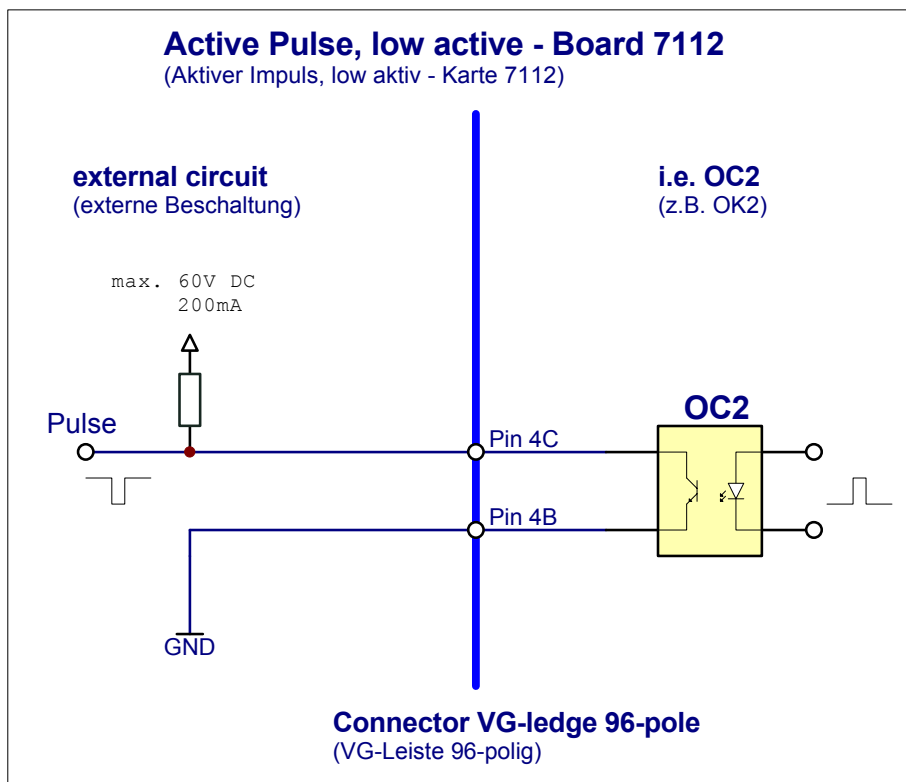
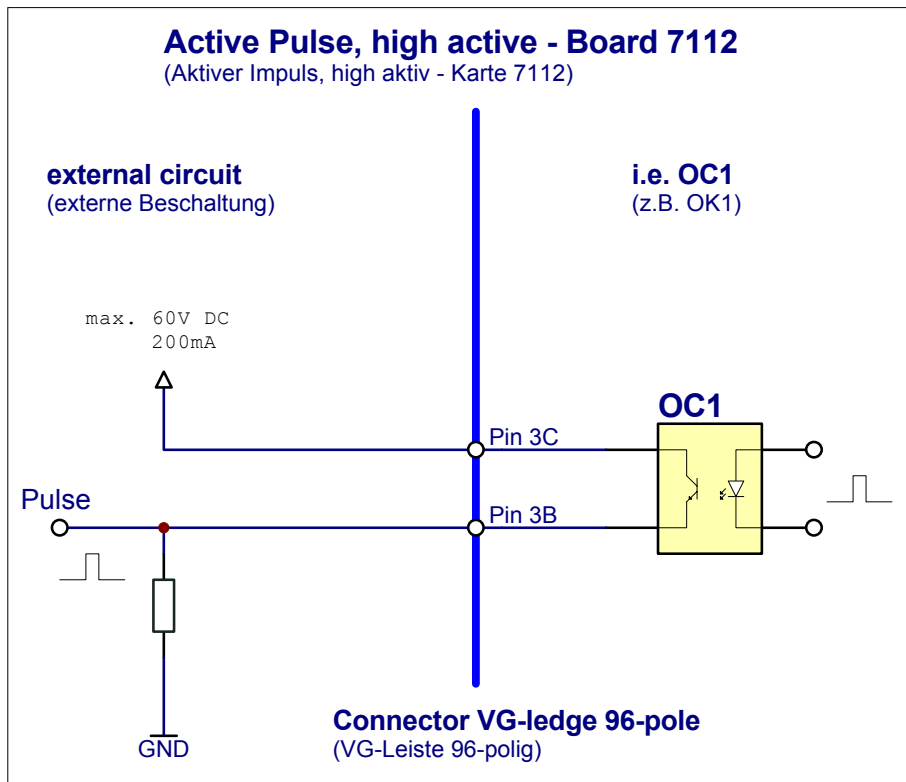

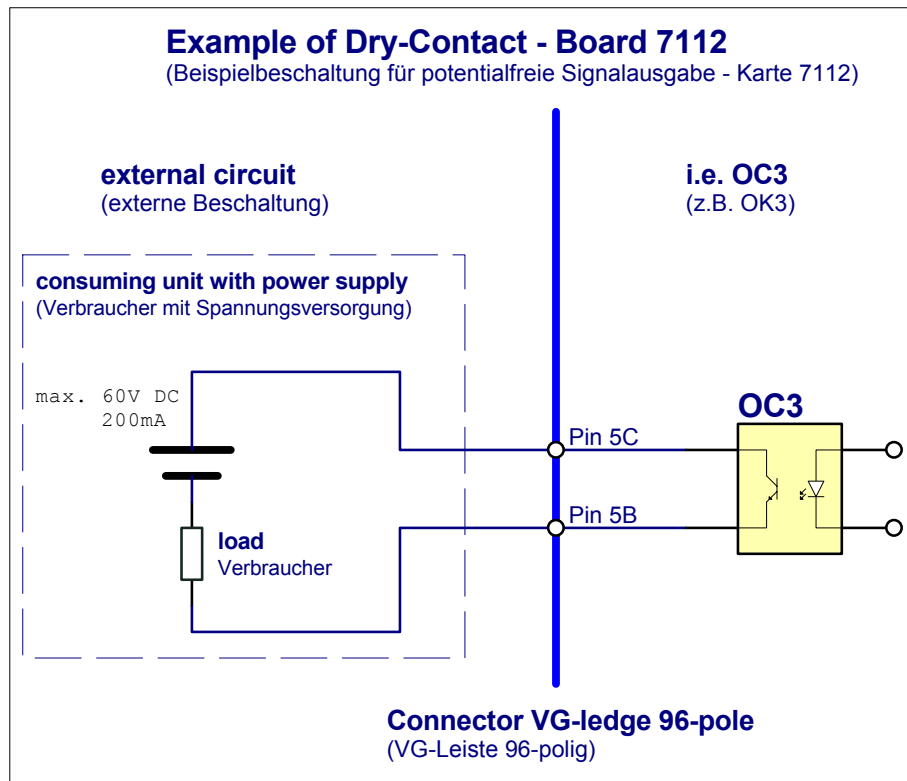

1.1.4 Technical Data - Board 7112

voltage supply:	+5V DC via bussystem
input current:	approx. 200mA
number of output optocouplers:	24
switching capacity of the outputs:	60V DC / 200mA
number of input optocouplers:	8
The input voltage of the optocouplers depends on the series resistor Rx: (Rx : R25 - R32)	Rx = 560 Ω (¼ Watt) ⇒ 5 Volt Rx = 5,6 kΩ (¼ Watt) ⇒ 18 to 36 Volt Rx = 12 kΩ (½ Watt) ⇒ 36 to 60 Volt
MTBF:	> 300.000 hours

Customer service:

- In- and output programming according to customer specification
- Hard- and software alterations according to customer specifications are available



The **hopf** company withhold the right to hard- and software alterations.

1.2 Relay Board 7121

The board 7121 has 24 relay outputs where potential free signals/pulses can be put out. There are also 8 optocoupler inputs for different tasks and purposes on the board.

The board contains its own microprocessor, which organise the synchronization with the system 7000 or 7001 and the in- and output.

The board can be configure for the use with the clock-system 7000 or 7001 with jumper **M0**.

1.2.1 Position Print

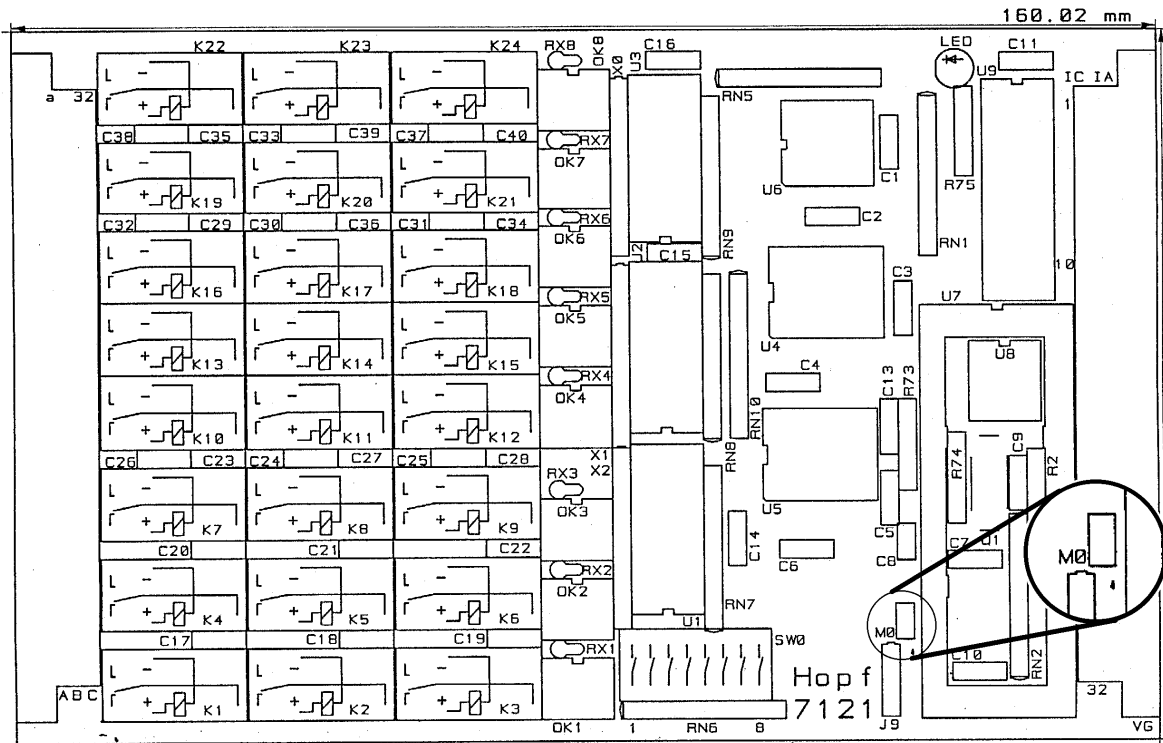

Setting for clock-system 7001 (Board 7015 as Master-Clock):

Jumper M0 open

Setting for clock-system 7000 (Board 7010 as Master-Clock):

Jumper M0 close

1.2.2 Contact Assignment of the 96-pole VG-Strip in the Front Panel

Signals: row a = normally open (no)
 row b = common (c)
 row c = normally close (nc)
 OA = anode of the input diode
 OK = cathode of the input diode

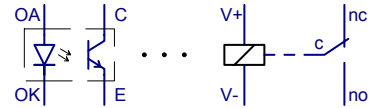

Pin	VG-strip				
	a	b	c		
1	OA		OK	input optocoupler 1	OC 1
2	OA		OK	input optocoupler 2	OC 2
3	no	c	nc	output relay 1	R 1
4	no	c	nc	output relay 2	R 2
5	no	c	nc	output relay 3	R 3
6	no	c	nc	output relay 4	R 4
7	no	c	nc	output relay 5	R 5
8	no	c	nc	output relay 6	R 6
9	no	c	nc	output relay 7	R 7
10	no	c	nc	output relay 8	R 8
11	OA		OK	input optocoupler 3	OC 3
12	OA		OK	input optocoupler 4	OC 4
13	no	c	nc	output relay 9	R 9
14	no	c	nc	output relay 10	R 10
15	no	c	nc	output relay 11	R 11
16	no	c	nc	output relay 12	R 12
17	no	c	nc	output relay 13	R 13
18	no	c	nc	output relay 14	R 14
19	no	c	nc	output relay 15	R 15
20	no	c	nc	output relay 16	R 16
21	OA		OK	input optocoupler 5	OC 5
22	OA		OK	input optocoupler 6	OC 6
23	no	c	nc	output relay 17	R 17
24	no	c	nc	output relay 18	R 18
25	no	c	nc	output relay 19	R 19
26	no	c	nc	output relay 20	R 20
27	no	c	nc	output relay 21	R 21
28	no	c	nc	output relay 22	R 22
29	no	c	nc	output relay 23	R 23
30	no	c	nc	output relay 24	R 24
31	OA		OK	input optocoupler 7	OC 7
32	OA		OK	input optocoupler 8	OC 8

1.2.3 Example Wiring for Relais Board 7121

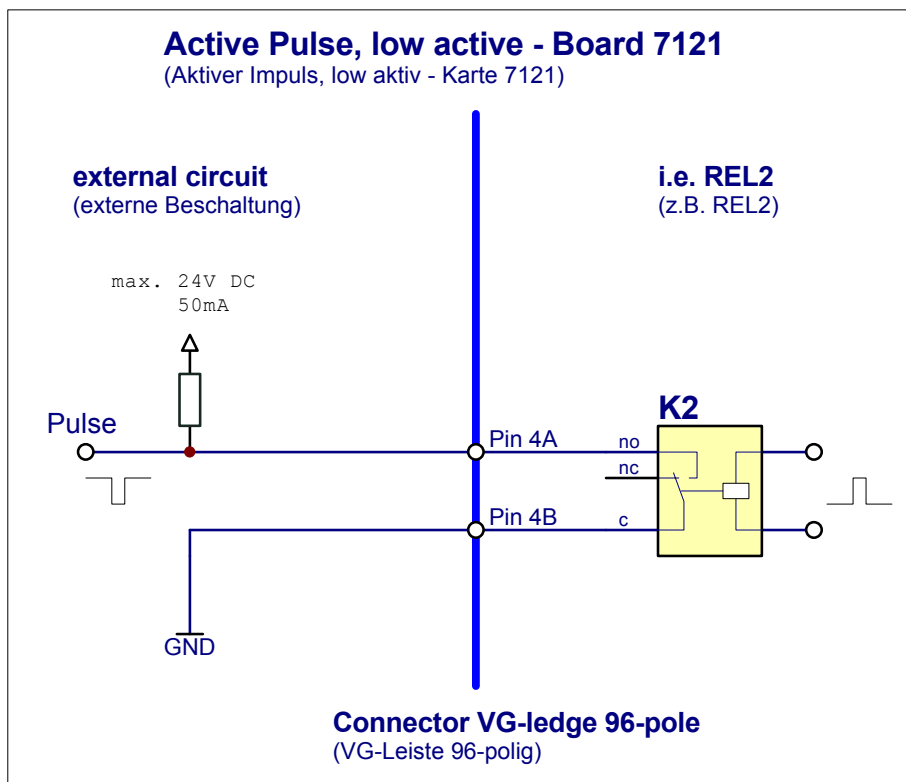
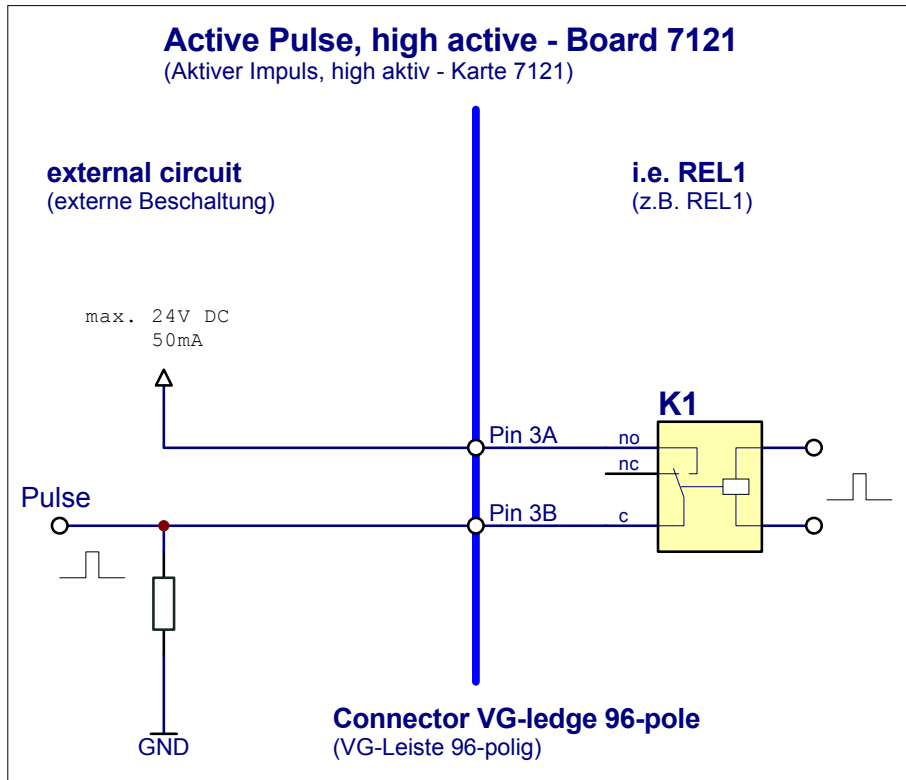

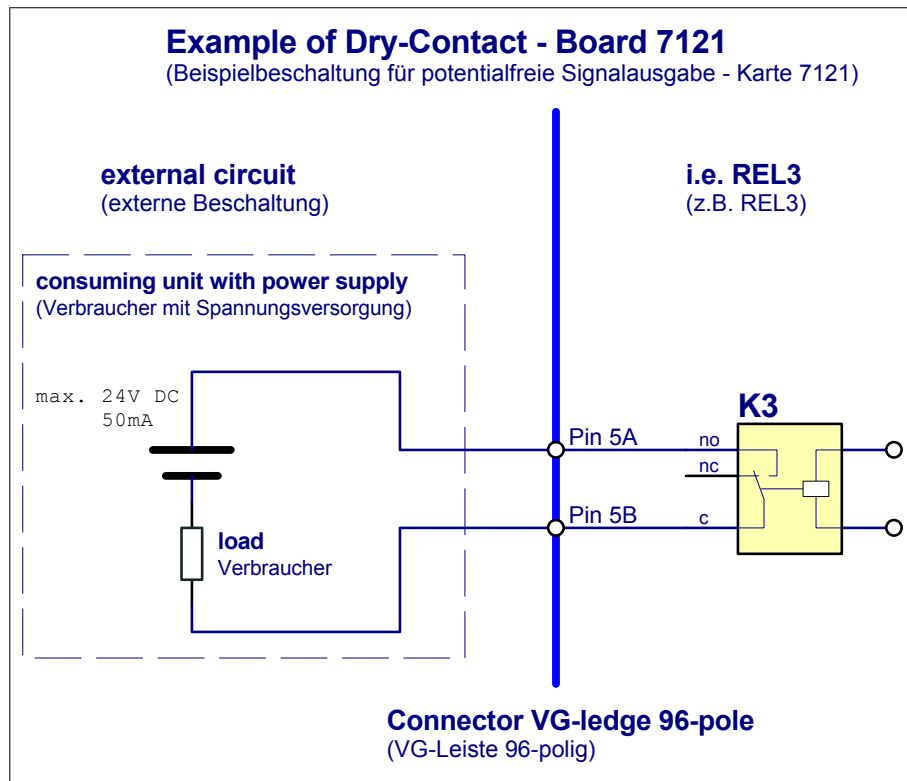

1.2.4 Technical Data - Board 7121

voltage supply:	+5V DC via bussystem
input current:	approx. 200mA
number of output relays:	24
switching capacity of the outputs:	24V DC / 200mA
expected life:	min. operations 1×10^9
number of input optocouplers:	8
The input voltage of the optocouplers depends on the series resistor Rx:	Rx = 560 Ω ($\frac{1}{4}$ Watt) \Rightarrow 5 Volt
(Rx : Rx1 - Rx8)	Rx = 5,6 k Ω ($\frac{1}{4}$ Watt) \Rightarrow 18 to 36 Volt
	Rx = 12 k Ω ($\frac{1}{2}$ Watt) \Rightarrow 36 to 60 Volt
MTBF:	> 300.000 hours, relays 10 million number of cycles

Customer service:

- In- and output programming according to customer specification
- Hard- and software alterations according to customer specifications are available



The **hopf** company withhold the right to hard and software alterations.

2 Operating Modes

The mode wanted can be selected by means of DIP-switch SW0 on the board.

Several functions can also be changed external by optocoupler during operating. The DIP-switches 1-3 in SW0 are switched logical parallel with the optical-coupler OC1-OC3 (OC8-OC6)¹.

Respectively it can only be used the external control via OC1-OC3 (OC8-OC6) or the internal control via DIP-switch if the other control port is off-line.

Example: Control via OC1 ⇒ switcher 1 in SW0 is OFF
Control via switcher 3 in SW0 ⇒ OC3 is OFF

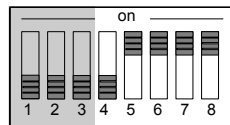

By DIP-switch 4-8 in SW0 the different output-modes will be changed. The switches 1+2 in SW0 or in the optical-coupler OC1+OC2 have different relevancy in individual modes.

2.1 Function of the Input Optocoupler

1. OC1 and OC2 (OC8 and OC7) are needed in mode 0 (output date or time) to change from date to time (see pt. 2.2.1)
2. The signal output can be inverted in every mode with OC3

setting OC3 (OC6)	setting SW 0 / 3	presentation BCD - code	presentation minute pulse
off	off	positive logic	negative logic
off	on	negative logic	positive logic
on	off	negative logic	positive logic
on	on	negative logic	positive logic

3. In special editions single relays will not be inverted.



optocoupler OFF ⇒ not connected

¹ The contents in the brackets are for the use with the board 7121.

2.2 DIP-Switch Settings

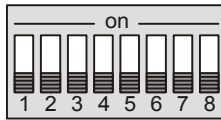

mode 0: output of either time or date as BCD-code

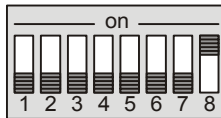

mode 1: output of 24 minute pulses (same pulse duration)

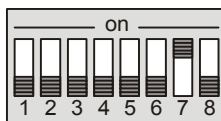

mode 2: output of 3x8 minute pulses (different pulse duration)

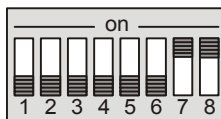

mode 3: output of 24 DCF77-simulation pulses



mode 4: output of error messages

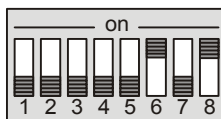

mode 5: output second pulses



mode 6: output date and status

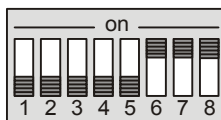

mode 7: output minute-, hour- and day pulses



mode 8: output minute-, toggle- and alarm pulses



mode 9: output of different pulses

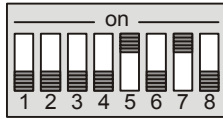

mode 10: output of different synchronous pulses

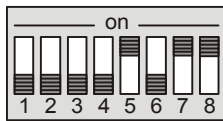

mode 11: output of different synchronous pulses

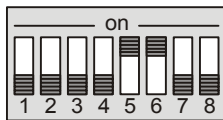

mode 12: output of different synchronous pulses

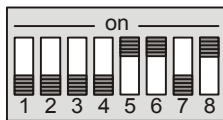

mode 13: output minute-, hour-, day pulses and status

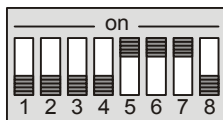

mode 14: output of synchronous pulses and error messages

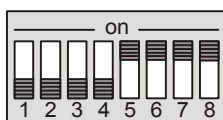

mode 15: output of hour pulses with a duration of 1 second on 24 outputs



mode 16: output second toggle pulse and minute pulse with 50 msec forerun



mode 17: output minute-, daylight saving time- and status bit

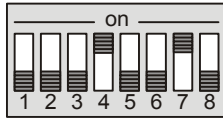

mode 18: output mains frequency and difference time

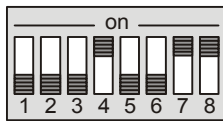

mode 19: output interference and hour pulse

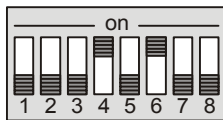

mode 20: output of 24 error messages

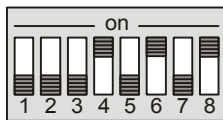

mode 21: output of hour, 15 minute and minute pulses

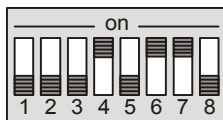

mode 22: output of different pulses and status

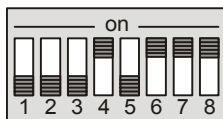

mode 23: output of hour pulses every hour



mode 24: output of minute pulses and 5 second pulses

◦
◦
◦

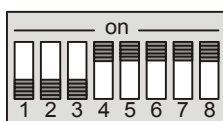

mode 31: test mode

2.2.1 Mode 0 : Output of Time as BCD-Information

Necessary setting for mode 0 see pt.2.2

Time or date output can be selected by either DIP-switch SW0 pos. 1+2 or optocoupler entry 1+2. The states of optocoupler entry and DIP-switch position are connected as a logical **OR**.

time output as BCD-information

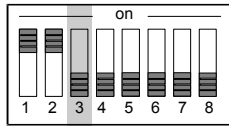

SW0		optocoupler	
S1	S2	OC1 (OC8)	OC2 (OC7)
on	on	off	off

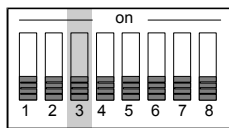

SW0		optocoupler	
S1	S2	OC1 (OC8)	OC2 (OC7)
off	off	on	on

time output as BCD information via OC / REL 1-24

optocoupler / relay	information	valence
1	tens digit hour	2 ³
2	tens digit hour	2 ²
3	tens digit hour	2 ¹
4	tens digit hour	2 ⁰
5	unit digit hour	2 ³
6	unit digit hour	2 ²
7	unit digit hour	2 ¹
8	unit digit hour	2 ⁰
9	tens digit minute	2 ³
10	tens digit minute	2 ²
11	tens digit minute	2 ¹
12	tens digit minute	2 ⁰
13	unit digit minute	2 ³
14	unit digit minute	2 ²
15	unit digit minute	2 ¹
16	unit digit minute	2 ⁰
17	tens digit second	2 ³
18	tens digit second	2 ²
19	tens digit second	2 ¹
20	tens digit second	2 ⁰
21	unit digit second	2 ³
22	unit digit second	2 ²
23	unit digit second	2 ¹
24	unit digit second	2 ⁰

date output as BCD-information

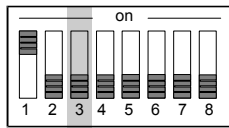

SW0		optocoupler	
S1	S2	OC1 (OC8)	OC2 (OC7)
on	off	off	off

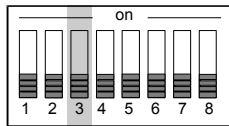

SW0		optocoupler	
S1	S2	OC1 (OC8)	OC2 (OC7)
off	off	on	off

date output as BCD information via OC / REL 1-24

optocoupler / relay	information	valence
1	tens digit day	2 ³
2	tens digit day	2 ²
3	tens digit day	2 ¹
4	tens digit day	2 ⁰
5	unit digit day	2 ³
6	unit digit day	2 ²
7	unit digit day	2 ¹
8	unit digit day	2 ⁰
9	tens digit month	2 ³
10	tens digit month	2 ²
11	tens digit month	2 ¹
12	tens digit month	2 ⁰
13	unit digit month	2 ³
14	unit digit month	2 ²
15	unit digit month	2 ¹
16	unit digit month	2 ⁰
17	tens digit year	2 ³
18	tens digit year	2 ²
19	tens digit year	2 ¹
20	tens digit year	2 ⁰
21	unit digit year	2 ³
22	unit digit year	2 ²
23	unit digit year	2 ¹
24	unit digit year	2 ⁰

2.2.2 Mode 1 : Output of 24 Minute Pulses (same pulse duration)

Necessary setting for mode 1 see pt. 2.2

OC / REL 1-24 ⇒ All minute pulses with pulse duration of 1 second.

2.2.3 Mode 2 : Output of 3x8 Minute Pulses (different pulse duration)

Necessary setting for mode 2 see pt. 2.2

OC / REL 1-8 ⇒ minute pulse with pulse duration of 1 second

OC / REL 9-16 ⇒ minute pulse with pulse duration of 500 milliseconds

OC / REL 17-24 ⇒ minute pulse with pulse duration of 100 milliseconds

2.2.4 Mode 3 : Output of 24 DCF77-Simulation Pulses

Necessary setting for mode 3 see pt. 2.2

OC / REL 1-24 ⇒ All DCF77-simulation

2.2.5 Mode 4 : Output of Error Messages

Necessary setting for mode 4 see pt. 2.2

The function of OC / REL 1-16 will be activated after the first radio reception.

1. The function of OC / REL 1-8 is set to **"8 hours - no receive"**
2. The function of OC / REL 17-24 describes the status function.
(Voltage **ON**: OC / REL **ON**, Voltage **OFF**: OC / REL **OFF**).
3. The function of OC / REL 9-16 can be delayed depending on the position of the DIP-switch SW0, position 1+2.
4. The function of OC / REL 1-24 can't be inverted depending on the position of the DIP-switch SW0 push button 3.

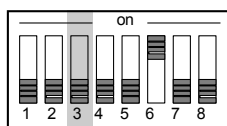

output not delayed (no receive)

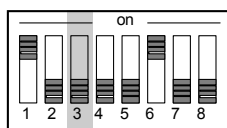

output delayed by 2 hours (no receive till 2h)

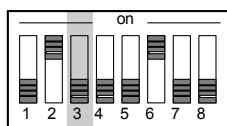

output delayed by 4 hours (no receive till 4h)

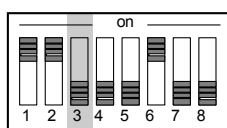

output delayed by 8 hours (no receive till 8h)

2.2.6 Mode 5 : Output of Second Pulses

Necessary setting for mode 5 see pt. 2.2

All outputs are occupied with a second pulse. The duration can be selected by SW0, position 1+2 or by OC1 and OC2 (OC8 and OC7).

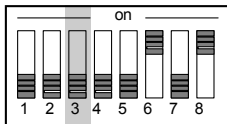

output 100 msec

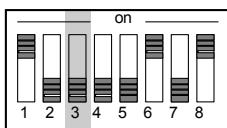

output 200 msec

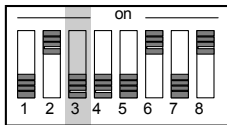

output 500 msec

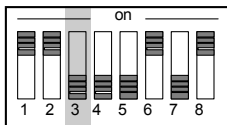

output 900 msec

2.2.7 Mode 6 : Output Date with Status

Necessary setting for mode 6 see pt. 2.2

date output as BCD information via OC / REL 1-24

optocoupler / relay	information	valence
1	tens digit day	2 ³
2	tens digit day	2 ²
3	tens digit day	2 ¹
4	tens digit day	2 ⁰
5	unit digit day	2 ³
6	unit digit day	2 ²
7	unit digit day	2 ¹
8	unit digit day	2 ⁰
9	STATUS-SYSTEM	2 ³
10	QUARTZ / RADIO	2 ²
11	SUMMER / WINTER	2 ¹
12	tens digit month	2 ⁰
13	unit digit month	2 ³
14	unit digit month	2 ²
15	unit digit month	2 ¹
16	unit digit month	2 ⁰
17	tens digit year	2 ³
18	tens digit year	2 ²
19	tens digit year	2 ¹
20	tens digit year	2 ⁰
21	unit digit year	2 ³
22	unit digit year	2 ²
23	unit digit year	2 ¹
24	unit digit year	2 ⁰

following special characters will faded into the output of the month:

- STATUS SYSTEM O.K. relay interconnected
- QUARTZ / RADIO relay interconnected at Radio
- SUMMER / WINTER relay interconnected at summertime

The switch off of the radio / quartzbit can be delayed. The delay will set with switch 1+2 in SW0. The same times like under mode 4 are effective.

2.2.8 Mode 7 : Output of Minute-, Hour-, Day Pulses

Necessary setting for mode 7 see pt. 2.2

output of:

- 4 * minute pulse, duration 1 second
- 4 * 2 minute pulse (even minute), duration 1 second
- 8 * hour pulse, duration 10 second
- 8 * day pulse at 03:00 am, duration 60 second

optocoupler / relay	pulse
1	day (03:00)
2	day (03:00)
3	day (03:00)
4	day (03:00)
5	day (03:00)
6	day (03:00)
7	day (03:00)
8	day (03:00)
9	hour
10	hour
11	hour
12	hour
13	hour
14	hour
15	hour
16	hour
17	minute
18	minute
19	minute
20	minute
21	2 minute (even)
22	2 minute (even)
23	2 minute (even)
24	2 minute (even)

2.2.10 Mode 9 : Output of Different Pulses

Necessary setting for mode 9 see pt. 2.2

Several pulses are available in mode 9.

optocoupler / relay	pulse
1	non-attached
2	non-attached
3	non-attached
4	11:55 - 12:00
5	11:55 - 12:00
6	11:55 - 12:00
7	11:55 - 12:00
8	½ hour
9	hour
10	hour
11	hour
12	day (00:00)
13	day (00:00)
14	day (00:00)
15	day (00:00)
16	day (00:00)
17	non-attached
18	non-attached
19	non-attached
20	non-attached
21	non-attached
22	non-attached
23	non-attached
24	non-attached

Output OC / REL 4-7

A pulse from 11:55h to 12:00h exists at this relay.

Output OC / REL 8

A pulse of 2 seconds duration exists at this relay. The beginning of the datatransfer is every hour respective at 00:30h, 01:30h, 02:30h etc.

Output OC / REL 9-11

A pulse of 1 second duration exists at this relay every full hour.

Output OC / REL 12-16

A pulse of 1 second duration exists at this relay every day at 00:00h.



Further OC / REL are not used.

2.2.11 Mode 10 : Output of Different Synchronous Pulses

Necessary setting for mode 10 see pt. 2.2

Several synchronous pulses are available in mode 10.

12	x	1	second pulse
8	x	1	minute pulse
1	x	10	minute pulses
1	x	15	minute pulses
1	x	30	minute pulses
1	x	60	minute pulses

pulse duration

The duration can be selected in four steps between 100, 200, 500 and 900 msec (see pt. 2.2.6).

The continuance for the other pulses is closely set to 1 second.

optocoupler / relay	pulse
1	second
2	second
3	second
4	second
5	second
6	second
7	second
8	second
9	second
10	second
11	second
12	second
13	minute
14	minute
15	minute
16	minute
17	minute
18	minute
19	minute
20	minute
21	10 minute pulse
22	15 minute pulse
23	30 minute pulse
24	60 minute pulse

2.2.12 Mode 11 : Output of Different Synchronous Pulses

Necessary setting for mode 11 see pt. 2.2

Several synchronous pulses are available in mode 11.

9	x	1	second pulse
9	x	1	minute pulse
4	x	1	hour pulse
2	x	1	day pulse at 00:00h

pulse duration

The continuance for all pulses is closely set to 200 msec.

optocoupler / relay	pulse
1	second
2	second
3	second
4	second
5	second
6	second
7	second
8	second
9	second
10	minute
11	minute
12	minute
13	minute
14	minute
15	minute
16	minute
17	minute
18	minute
19	hour
20	hour
21	hour
22	hour
23	day (00:00)
24	day (00:00)

2.2.13 Mode 12 : Output of Different Synchronous Pulses

Necessary setting for mode 12 see pt. 2.2

Several synchronous pulses are available in mode 12.

18	x	1	second pulse
6	x	1	minute pulse

pulse duration

The duration can be selected in four steps between 100, 200, 500 and 900 msec (see pt. 2.2.6).

The continuance for the minute pulses is closely set to 1 second.

optocoupler / relay	pulse
1	second
2	second
3	second
4	second
5	second
6	second
7	second
8	second
9	second
10	second
11	second
12	second
13	second
14	second
15	second
16	second
17	second
18	second
19	minute
20	minute
21	minute
22	minute
23	minute
24	minute

2.2.14 Mode 13 : Output Minute-, Hour, Day Pulses and Status

Necessary setting for mode 13 see pt. 2.2

Several synchronous pulses are available in mode 13.

8	x	1	minute pulse
4	x	1	hour pulse
4	x	1	day pulse at 00:00h
1	x	1	status System in progress
1	x	1	status System radio controlled
6	x	1	day pulse at 12:00h

pulse duration

The continuance for all pulses is closely set to 1 second.

In case of true status messages the OC / REL are interconnected.

optocoupler / relay	pulse
1	minute
2	minute
3	minute
4	minute
5	minute
6	minute
7	minute
8	minute
9	hour
10	hour
11	hour
12	hour
13	day (00:00)
14	day (00:00)
15	day (00:00)
16	day (00:00)
17	status "in progress"
18	status "radio controlled"
19	day (12:00)
20	day (12:00)
21	day (12:00)
22	day (12:00)
23	day (12:00)
24	day (12:00)

2.2.15 Mode 14 : Output of Different Synchronous Pulses and Error Messages

Necessary setting for mode 14 see pt. 2.2

Several synchronous pulses are available in mode 14.

18	x	1	second pulse
5	x	1	minute pulse
1	x	1	error message

pulse duration

The continuance for the second pulses is closely set to 200 msec.

The continuance for the minute pulses is closely set to 1 second.

optocoupler / relay	pulse
1	second
2	second
3	second
4	second
5	second
6	second
7	second
8	second
9	second
10	second
11	second
12	second
13	second
14	second
15	second
16	second
17	second
18	second
19	minute
20	minute
21	minute
22	minute
23	minute
24	error message

The function of OC / REL 24

- can be delayed depending on the position of the DIP-switch SW0 push button 1+2
- can't be inverted depending on the position of the DIP-switch SW0 push button 3

see positions of DIP-switches at pt. 2.2.5

2.2.16 Mode 15 : Output of Hour Pulses (Same Pulse Duration)

Necessary setting for mode 15 see pt. 2.2

The following pulses are available in mode 15.

24 x 1 hour pulse

pulse duration

All hour pulses with pulse duration of 1 second.

optocoupler / relay	pulse
1	hour
2	hour
3	hour
4	hour
5	hour
6	hour
7	hour
8	hour
9	hour
10	hour
11	hour
12	hour
13	hour
14	hour
15	hour
16	hour
17	hour
18	hour
19	hour
20	hour
21	hour
22	hour
23	hour
24	hour

2.2.17 Mode 16 : Output of Different Synchronous Pulses

Necessary setting for mode 16 see pt. 2.2

The following pulses are available in mode 16.

18	x	1	second-toggle pulse
5	x	1	minute pulse
1	x	1	status radio controlled

pulse duration

The optocouplers or relays are switched on during the second-toggle in the even seconds 0, 2, 4 etc. and they are switched off in the odd seconds 1, 3, 5 etc.

The pulse width for the minute pulse is 1050 msec with 50 msec advance before the minute change.

In case of radio reception OC / REL 24 is switched active.

optocoupler / relay	pulse
1	second
2	second
3	second
4	second
5	second
6	second
7	second
8	second
9	second
10	second
11	second
12	second
13	second
14	second
15	second
16	second
17	second
18	second
19	minute
20	minute
21	minute
22	minute
23	minute
24	status radio controlled

2.2.18 Mode 17 : Output of Minute-, Daylight Saving Time- and Status Bit

Necessary setting for mode 17 see pt. 2.2

The following pulses resp. information are available in mode 17.

6	x	1	minute pulse 10 msec duration
6	x	1	minute pulse 100 msec duration
7	x		daylight saving time information
5	x		radio/crystal status information

pulses

The optocoupler for the function status information are switched on after the system is radio controlled. According to the settings of DIP-switch SW0 position 1+2, they can be switched back delayed (see mode 4).



The status information and daylight saving time information can't be inverted depending on the position of the DIP-switch SW0 push button 3.

optocoupler / relay	pulse	duration
1	minute	10 msec
2	minute	10 msec
3	minute	10 msec
4	minute	10 msec
5	minute	10 msec
6	minute	10 msec
7	minute	100 msec
8	minute	100 msec
9	minute	100 msec
10	minute	100 msec
11	minute	100 msec
12	minute	100 msec
13	daylight saving bit	
14	daylight saving bit	
15	daylight saving bit	
16	daylight saving bit	
17	daylight saving bit	
18	daylight saving bit	
19	daylight saving bit	
20	radio/crystal bit	
21	radio/crystal bit	
22	radio/crystal bit	
23	radio/crystal bit	
24	radio/crystal bit	

2.2.19 Mode 18 : Output Mains Frequency and Difference Time

Required setting for mode 18 see pt. 2.2

If the network analysis board 7515 is operating in the system, this mode can be used to put out the values paralelly.

The DIP-switches S1 and S2 select the values which are to be put out.

<u>S1</u>	<u>S2</u>	
off	off	mains frequency
on	off	difference time
off	on	not used at present
on	on	not used at present

The mains frequency is put out in 5 digits in Hz with a resolution of 1 mHz. The output is updated about every second. A release-guard signal is taken back during the up-date.

The difference time is also put out in 5 digits. The range is fixed to $\pm 99,999$ seconds.

The data for the mains frequency and difference time are shown in BCD.

The logic level for the release-guard signal and the sign of the difference time are fixed as follows and cannot be inverted by push button 3 in the DIP-switch.

data are released, optocoupler 3 switched on

up-date of data in progress, optocoupler 3 switched off

difference time negative, optocoupler 4 switched off

difference time positive, optocoupler 4 switched on

Values of the optocoupler during output of frequency

optocoupler / relay	information	value
1		2^3
2		2^2
3	release	2^1
4		2^0
5	tens Hz	2^3
6	tens Hz	2^2
7	tens Hz	2^1
8	tens Hz	2^0
9	unit Hz	2^3
10	unit Hz	2^2
11	unit Hz	2^1
12	unit Hz	2^0
13	0.1 Hz	2^3
14	0.1 Hz	2^2
15	0.1 Hz	2^1
16	0.1 Hz	2^0
17	0.01 Hz	2^3
18	0.01 Hz	2^2
19	0.01 Hz	2^1
20	0.01 Hz	2^0
21	0.001 Hz	2^3
22	0.001 Hz	2^2
23	0.001 Hz	2^1
24	0.001 Hz	2^0

Value of the optocoupler during output of difference time

optocoupler / relay	information	value
1		2 ³
2		2 ²
3	release	2 ¹
4	plus/minus	2 ⁰
5	tens second	2 ³
6	tens second	2 ²
7	tens second	2 ¹
8	tens second	2 ⁰
9	unit second	2 ³
10	unit second	2 ²
11	unit second	2 ¹
12	unit second	2 ⁰
13	0.1 second	2 ³
14	0.1 second	2 ²
15	0.1 second	2 ¹
16	0.1 second	2 ⁰
17	0.01 second	2 ³
18	0.01 second	2 ²
19	0.01 second	2 ¹
20	0.01 second	2 ⁰
21	0.001 second	2 ³
22	0.001 second	2 ²
23	0.001 second	2 ¹
24	0.001 second	2 ⁰

2.2.20 Mode 19 : Output of Error Messages and Hour Pulses

Required settings for mode 19 see pt.2.2.

Error messages and hour pulses are put out via the optocouplers / relays.

The function of the OK / REL 1 represents the operating status

(voltage **on** : OK / REL **ON** – voltage **off** : OK / REL **OFF**).

The function OK / REL 9 is activated after the first radio reception and shows if the system is running radio synchronously or not. The DIP-switch SW0 can be used to delay the change to radio interference.

(radio synchronous : OK / REL **ON** – not synchronous off : OK / REL **OFF**).

The function OK / REL 17 is giving out the operating mode of the internal data bus.

OK / REL **ON** internal Data bus is active
 OK / REL **OFF** internal Data bus is inactive (error)

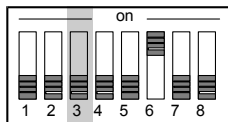

output not delayed (no radio reception)

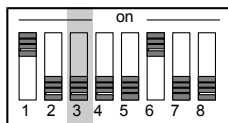

output delayed by 2 hours (no radio reception for 2 hours)

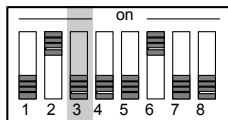

output delayed by 4 hours (no radio reception for 4 hours)

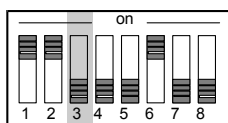

output delayed by 8 hours (no radio reception for 8 hours)

The functions of the OK / REL 1, 9 and 17 cannot be inverted by means of the DIP-switch SW0, position 3.

Hour pulses are put out at the optocouplers / relays 2-8 and 10-16. The pulses last for 1 second.

The optocouplers / relays 18-24 are not in use at present.

2.2.21 Mode 20 : Output of 24 Error Messages

Required setting for mode 20 please see point 2.2.

The OC / REL 1-24 are controlled by the DIP-switch SWO position 1 and 2 as mentioned in the table below.

Operation mode: Voltage **on** : OC / REL **ON** - Voltage **off** : OC / REL **OFF**

Radio Reception:

Time without reception larger than delay time or no reception since switch on:

- OC / REL **OFF**

Time without reception smaller than delay time:

- OC / REL **ON**

The function of the OC / REL 1-24 can't be inverted by setting the DIP-switch SWO, position 3.

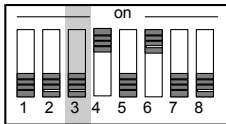

Operating mode

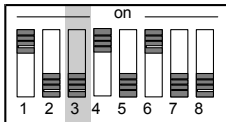

output not delayed (no radio reception)

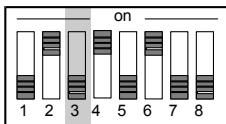

output delayed by 2 hours (no radio reception for 2 hours)

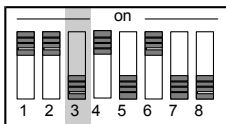

output delayed by 8 hours (no radio reception for 8 hours)

2.2.22 Mode 21 : Output of Hour, 15 Minute and Minute Pulses

Required setting for mode 21 please see point 2.2.

In Mode 21 the following pulses are put out:

- 1 x hour pulse with 2 sec duration
- 2 x 15 minute pulse with 2 sec duration
- 3 x minute pulse with adjustable pulse duration
- 1 x minute pulse with 2 sec duration

Mode 21 is provided for the FG711250 witch is placed with only 8 output optocouplers.

optocoupler / relay	pulse	duration
1	hour	2 sec
2	not placed	
3	not placed	
4	15 minute	2 sec
5	not placed	
6	not placed	
7	15 minute	2 sec
8	not placed	
9	not placed	
10	minute	adjustable
11	not placed	
12	not placed	
13	minute	adjustable
14	not placed	
15	not placed	
16	minute	adjustable
17	not placed	
18	not placed	
19	minute	2 sec
20	not placed	
21	not placed	
22	no function	
23	not placed	
24	not placed	

All pulses can be inverted with DIP-switch 3.

Pulse Duration

With DIP-switch 1 and 2 the pulse duration of the standard minute pulses can be set to 100 ms, 200 ms, 500 ms and 1 second.

S1	S2	pulse duration
off	off	100 ms
off	on	200 ms
on	off	500 ms
on	on	1 sec

2.2.23 Mode 22 : Output of Different Pulses and Status

Required setting for mode 22 please see point 2.2.

In Mode 22 the following pulses are put out:

optocoupler / relay	pulse	duration
1	minute	1 sec
2	minute	1 sec
3	minute	1 sec
4	minute	1 sec
5	minute	1 sec
6	minute	1 sec
7	minute	1 sec
8	minute	1 sec
9	daylight saving time bit	
10	daylight saving time bit	
11	daylight saving time bit	
12	daylight saving time bit	
13	daylight saving time bit	
14	daylight saving time bit	
15	daylight saving time bit	
16	daylight saving time bit	
17	operating report	
18	status "radio controlled"	
19	day of the month toggle ¹	
20	inverted day of the month toggle	
21	free	
22	second toggle ²	
23	hour	10 sec
24	change of day 60s	60 sec

¹ Optocoupler/Relay switched **on** at even days an switched **off** at odd days

² Optocoupler/Relay switched **on** at even seconds and switched **off** at odd seconds

2.2.24 Mode 23 : Output of Hour Pulses every Hour

Required setting for mode 23 please see point 2.2.

In each case a pulse of 1 second duration is sent at the output channel (optocoupler/relay) at the hour change.

optocoupler / relay	pulse	duration
1	1 am	1 sec
2	2 am	1 sec
3	3 am	1 sec
4	4 am	1 sec
5	5 am	1 sec
6	6 am	1 sec
7	7 am	1 sec
8	8 am	1 sec
9	9 am	1 sec
10	10 am	1 sec
11	11 am	1 sec
12	12 pm	1 sec
13	1 pm	1 sec
14	2 pm	1 sec
15	3 pm	1 sec
16	4 pm	1 sec
17	5 pm	1 sec
18	6 pm	1 sec
19	7 pm	1 sec
20	8 pm	1 sec
21	9 pm	1 sec
22	10 pm	1 sec
23	11 pm	1 sec
24	12 am	1 sec



In case of a changeover from standard time to daylight saving time the pulse at 2 o'clock is omitted. At the change over point from daylight saving time to standard time the pulse output repeats at 2 o'clock.

2.2.25 Mode 24 : Output of Minute and 5 Second Pulses

Necessary setting for mode 24 see pt. 2.2

Several synchronous pulses are available in mode 24.

8	x	5 second pulse
16	x	1 minute pulse

pulse duration

The continuance for the 5 second pulses is closely set to 200 msec..

The continuance for the minute pulses is closely set to 1 second.

optocoupler / relay	pulse
1	minute
2	minute
3	minute
4	minute
5	minute
6	minute
7	minute
8	minute
9	minute
10	minute
11	minute
12	minute
13	minute
14	minute
15	minute
16	minute
17	every 5 seconds
18	every 5 seconds
19	every 5 seconds
20	every 5 seconds
21	every 5 seconds
22	every 5 seconds
23	every 5 seconds
24	every 5 seconds